

FLOS

09.4842.14ADA Black

UT Spot Track Ø 86 Dali Version

Designed by FLOS Architectural, 2017



Spotlight to be installed on 3-phase track. with LED light source. 220-240V, 50-60Hz power supply integrated.

Are you a professional and your project needs consulting and support?

[BOOK AN APPOINTMENT](#)

Main specifications

Mounting	Track
Environments	Indoor dry location
Light Source Type	LED
LED type	LED array
Lamp category	LED
Iicos	No
Bulb finish	Clear
Number of heads	1
Power (W)	32.8
System power (W)	32.8
Source flux (lm)	3959
System flux (lm)	2408

Physical

Colour	Black
Trim	No
Orientation	Adjustable
Rotation (°)	360
Longitudinal tilting (°)	90
Spot diameter (mm)	86
Net weight (kg)	0.74
IP internal	20
IP external	20

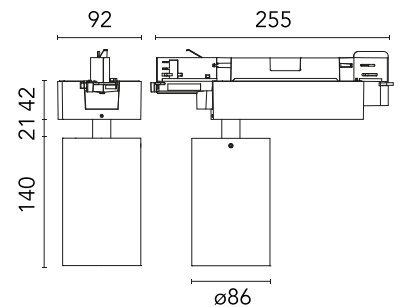

Download

[Mounting instructions](#)  ZIP

Photometric Files

[LDT / IES](#)  ZIP

Technical Drawings

[2D](#)  ZIP

[3D](#)  ZIP

[Bim](#)  ZIP



Schematic light drawing

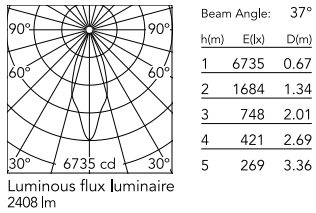

Photometric

Lighting type	Direct
Light distribution	Symmetric
CCT (K)	3000
CRI>	80
Beam angle C0-180 (°)	37
Beam angle C90-270 (°)	37

Electrical

Insulation class	II
Frequency (Hz)	50/60
Main voltage (Vac)	220-240V
Alternating current voltage (Vac)	230
LED current (mA)	900
Driver	Integrated
Dimmable	Yes
Dimming type	Dimmable DALI 1
Dimming interface	Remote Dimmable (Dimmer Not Included)
Emergency type	No

Notes

FLOS three-phase lighting track luminaires are designed and fully tested for tracks recommended by FLOS. Compatibility is guaranteed with three-phase track produced by Nordic Aluminium. Compatibility with Eutrac under request. FLOS three-phase DALI track luminaires are designed for Pulse DALI from Nordic Aluminium.

Ecodesign and Energy Labelling



Replaceable (LED only) light source by a professional



Replaceable control gear by a professional

Accessories & Power Supply



OPTIONAL
Accessory

Optical

08.8163.68

Elliptical lens



OPTIONAL
Accessory

Optical

08.8175.68

Flood lens



OPTIONAL
Accessory

Optical

08.8410.00

Holding ring



OPTIONAL
Accessory

Optical

08.8411.00

Screening crosspiece



OPTIONAL
Accessory

Optical

08.8495.14

Honeycomb